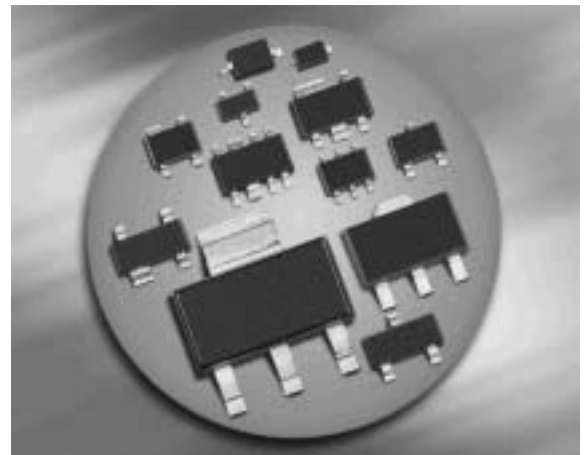
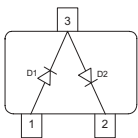
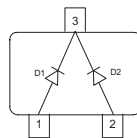
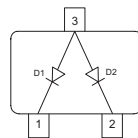
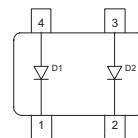

Silicon Schottky Diodes

- For low-loss, fast-recovery, meter protection, bias isolation and clamping application
- Integrated diffused guard ring
- Low forward voltage
- Pb-free (RoHS compliant) package ¹⁾
- Qualified according AEC Q101

BAS125-04W

BAS125-05W

BAS125-06W

BAS125-07W

ESD (Electrostatic discharge) sensitive device, observe handling precaution!

Type	Package	Configuration	L_S (nH)	Marking
BAS125-04W	SOT323	series	1.4	14s
BAS125-05W	SOT323	common cathode	1.4	15s
BAS125-06W	SOT323	common anode	1.4	16s
BAS125-07W	SOT343	parallel pair	1.6	17s

Maximum Ratings at $T_A = 25^\circ\text{C}$, unless otherwise specified

Parameter	Symbol	Value	Unit
Diode reverse voltage	V_R	25	V
Forward current	I_F	100	mA
Non-repetitive peak surge forward current	I_{FSM}	500	
Total power dissipation	P_{tot}		mW
BAS125-04W, BAS125-06W, $T_S \leq 84^\circ\text{C}$		250	
BAS125-05W, $T_S \leq 76^\circ\text{C}$		250	
BAS125-07W, $T_S \leq 96^\circ\text{C}$		250	
Junction temperature	T_j	150	$^\circ\text{C}$
Storage temperature	T_{stg}	-55 ... 150	

¹Pb-containing package may be available upon special request

Thermal Resistance

Parameter	Symbol	Value	Unit
Junction - soldering point ¹⁾ BAS125-04W, BAS125-06W BAS125-05W BAS125-07W	R_{thJS}	≤ 365 ≤ 295 ≤ 215	K/W

Electrical Characteristics at $T_A = 25^\circ\text{C}$, unless otherwise specified

Parameter	Symbol	Values			Unit
		min.	typ.	max.	

DC Characteristics

Reverse current $V_R = 20\text{ V}$ $V_R = 25\text{ V}$	I_R	- -	- -	100 150	nA
Forward voltage $I_F = 1\text{ mA}$ $I_F = 10\text{ mA}$ $I_F = 35\text{ mA}$	V_F	- - -	385 530 800	400 650 950	mV
Forward voltage matching ²⁾ $I_F = 10\text{ mA}$	ΔV_F	-	-	20	

AC Characteristics

Diode capacitance $V_R = 0$, $f = 1\text{ MHz}$	C_T	-	-	1.1	pF
Differential forward resistance $I_F = 5\text{ mA}$, $f = 10\text{ kHz}$	R_F	-	15	-	Ω

¹⁾For calculation of R_{thJA} please refer to Application Note Thermal Resistance

²⁾ ΔV_F is the difference between lowest and highest V_F in a multiple diode component.

Diode capacitance $C_T = f(V_R)$

$f = 1\text{MHz}$

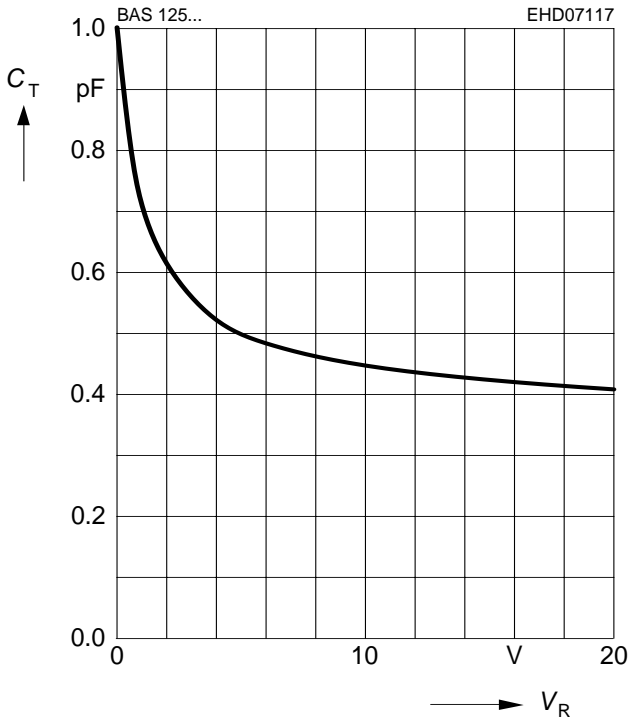

Forward resistance $r_f = f(I_F)$

$f = 10\text{kHz}$

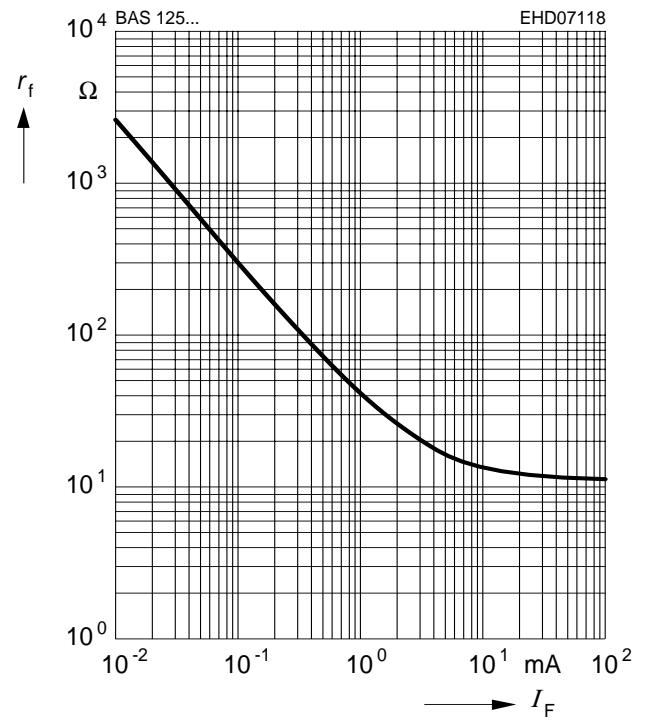

Reverse current $I_R = f(V_R)$

$T_A = \text{Parameter}$

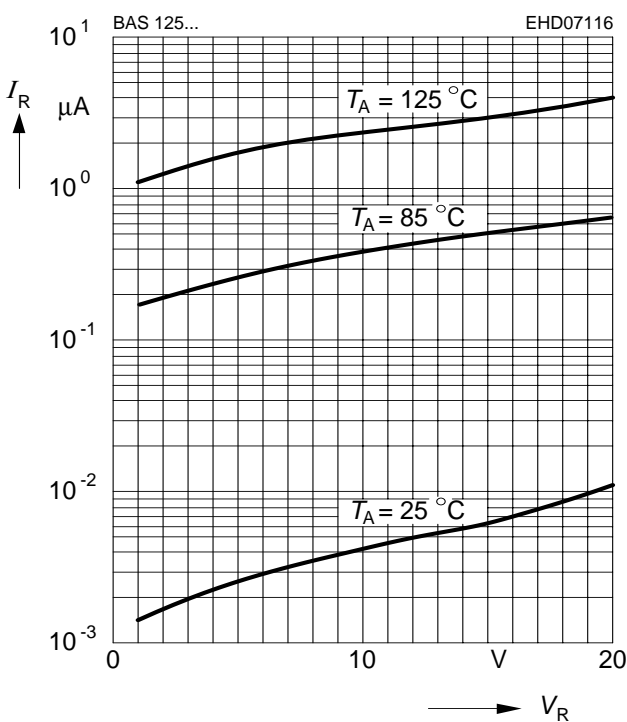

Forward current $I_F = f(V_F)$

$T_A = \text{Parameter}$

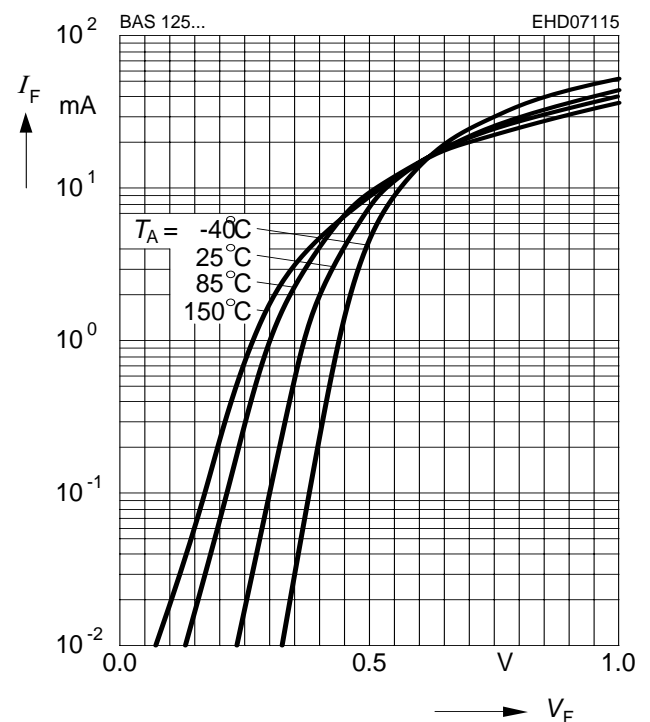

Forward current $I_F = f(T_S)$

BAS125-04W, BAS125-06W

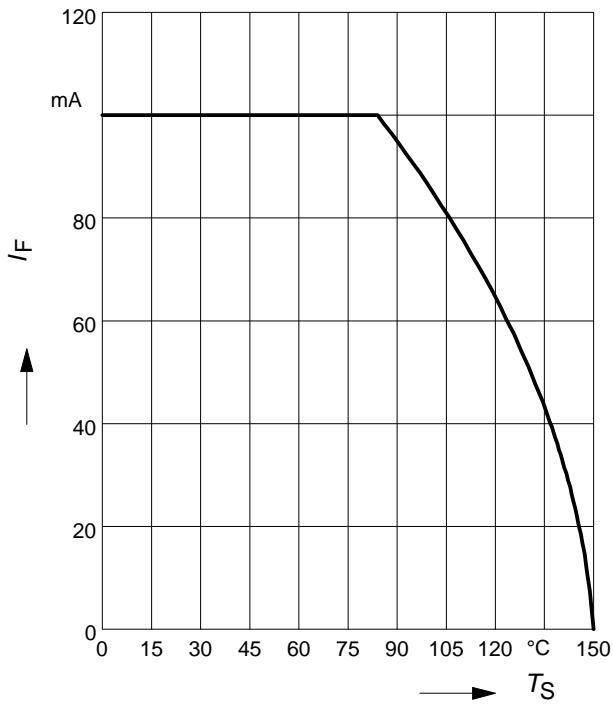

Forward current $I_F = f(T_S)$

BAS125-05W

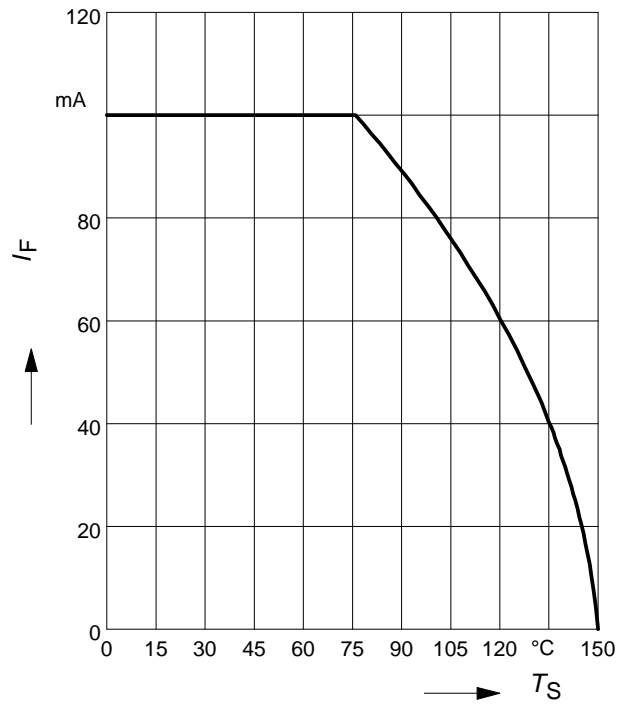

Forward current $I_F = f(T_S)$

BAS125-07W

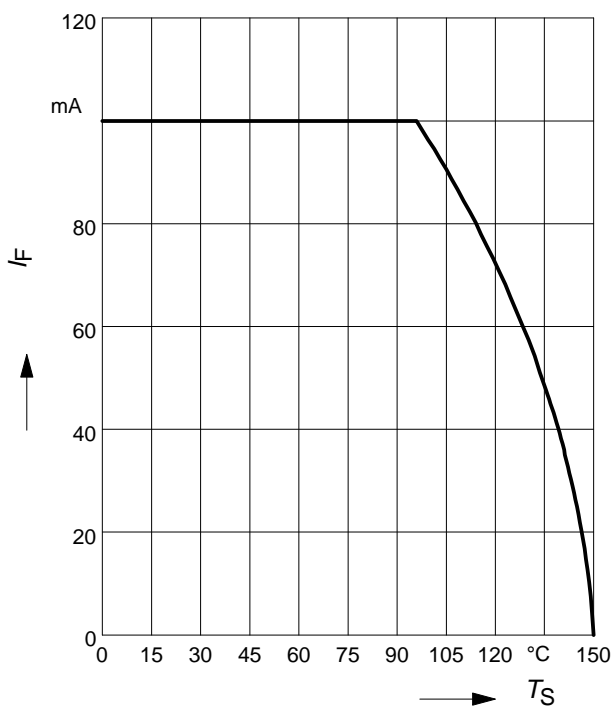

Permissible Puls Load $R_{thJS} = f(t_p)$

BAS125-04W, BAS125-06W

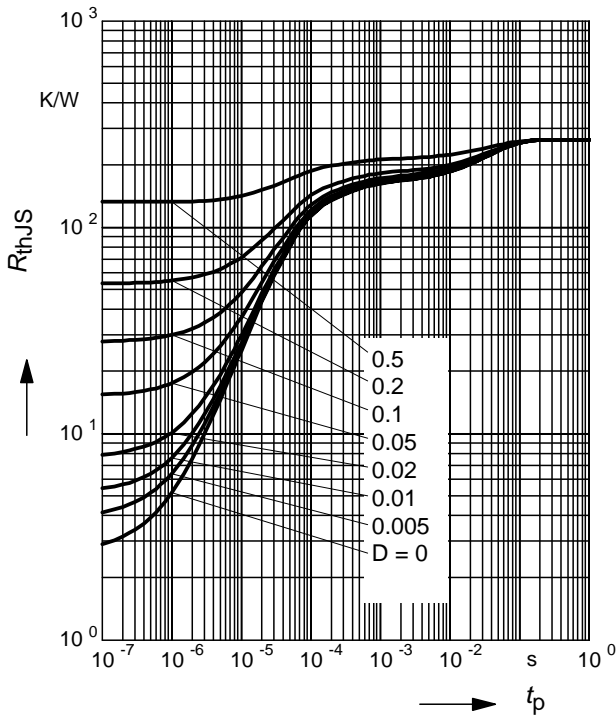

Permissible Pulse Load

$I_{Fmax} / I_{FDC} = f(t_p)$

BAS125-04W, BAS125-06W

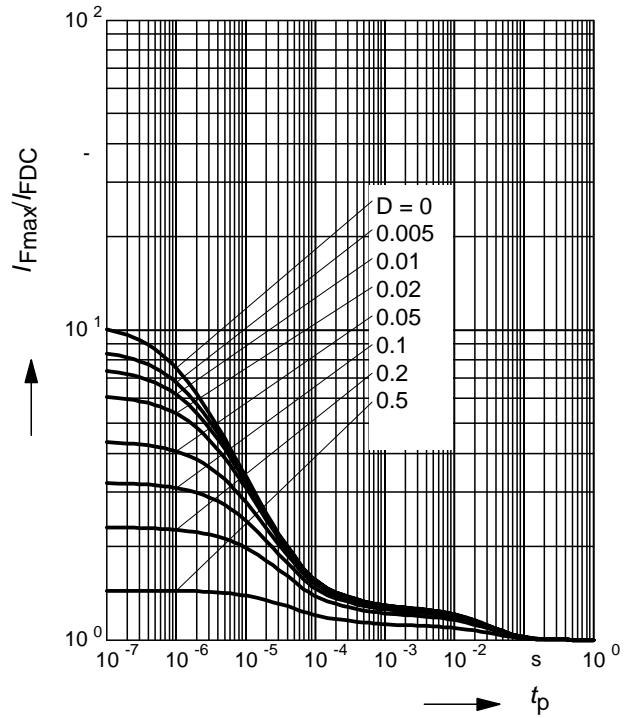

Permissible Puls Load $R_{thJS} = f(t_p)$

BAS125-05W

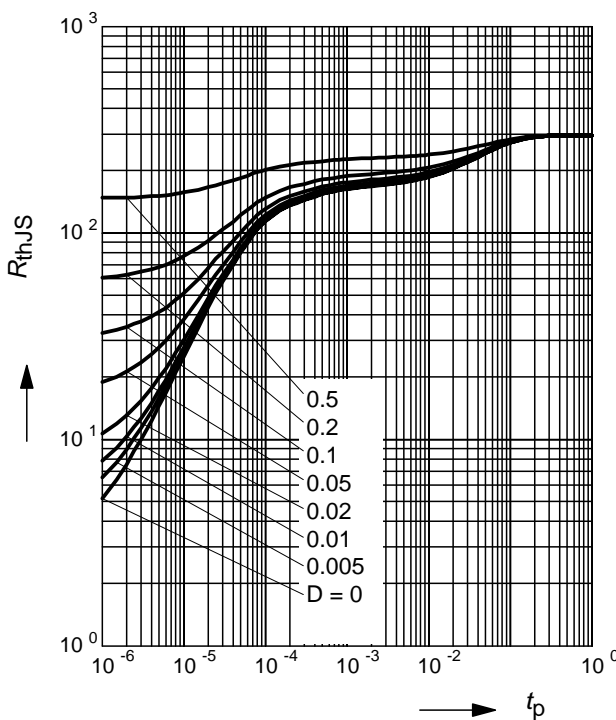

Permissible Pulse Load

$I_{Fmax} / I_{FDC} = f(t_p)$

BAS125-05W

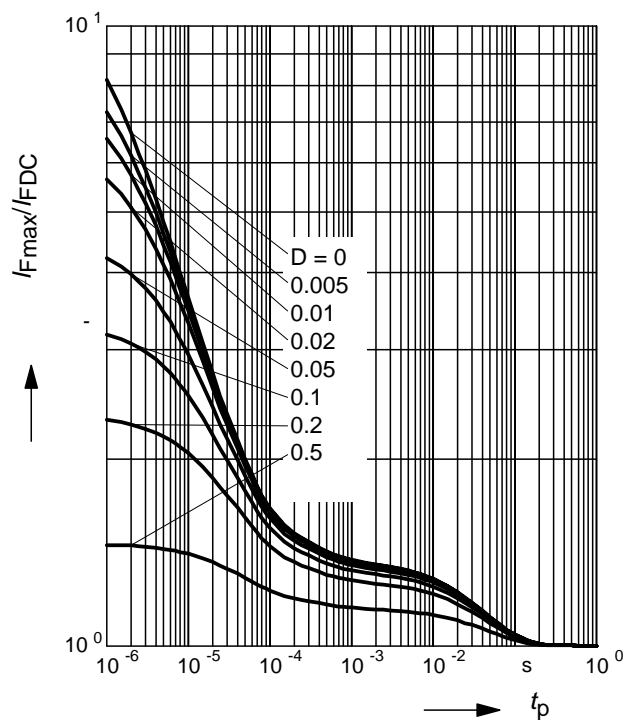

Package Outline

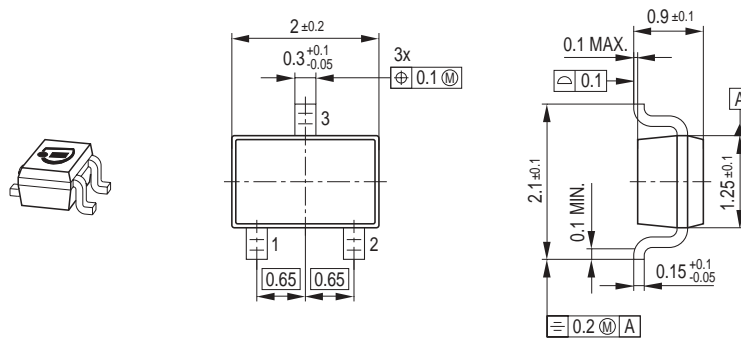

Foot Print

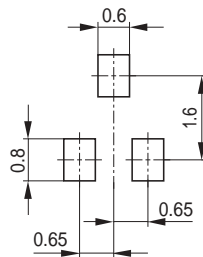

Marking Layout (Example)

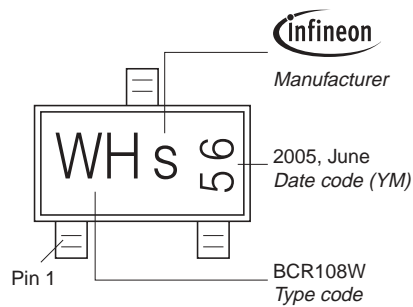

Standard Packing

Reel \varnothing 180 mm = 3.000 Pieces/Reel
 Reel \varnothing 330 mm = 10.000 Pieces/Reel

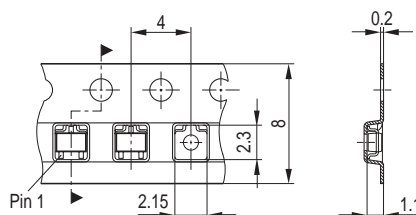

Package Outline

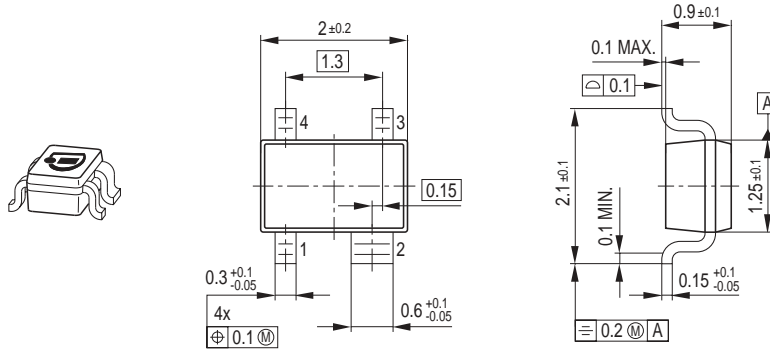

Foot Print

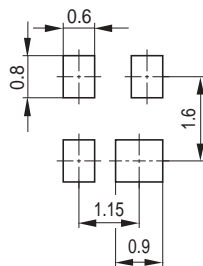

Marking Layout (Example)

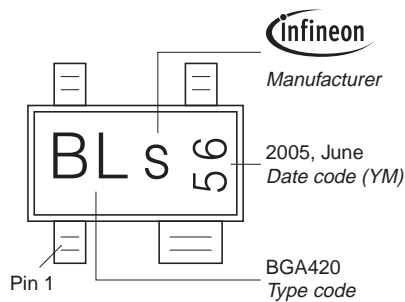

Standard Packing

Reel ø180 mm = 3.000 Pieces/Reel
 Reel ø330 mm = 10.000 Pieces/Reel

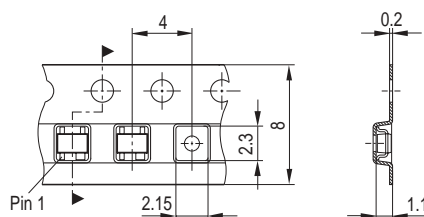

Edition 2006-02-01
Published by
Infineon Technologies AG
81726 München, Germany
© Infineon Technologies AG 2007.
All Rights Reserved.

Attention please!

The information given in this dokument shall in no event be regarded as a guarantee of conditions or characteristics ("Beschaffenheitsgarantie"). With respect to any examples or hints given herein, any typical values stated herein and/or any information regarding the application of the device, Infineon Technologies hereby disclaims any and all warranties and liabilities of any kind, including without limitation warranties of non-infringement of intellectual property rights of any third party.

Information

For further information on technology, delivery terms and conditions and prices please contact your nearest Infineon Technologies Office (www.infineon.com).

Warnings

Due to technical requirements components may contain dangerous substances. For information on the types in question please contact your nearest Infineon Technologies Office.

Infineon Technologies Components may only be used in life-support devices or systems with the express written approval of Infineon Technologies, if a failure of such components can reasonably be expected to cause the failure of that life-support device or system, or to affect the safety or effectiveness of that device or system.

Life support devices or systems are intended to be implanted in the human body, or to support and/or maintain and sustain and/or protect human life. If they fail, it is reasonable to assume that the health of the user or other persons may be endangered.

单击下面可查看定价，库存，交付和生命周期等信息

[>>Infineon Technologies\(英飞凌\)](#)

[>>点击查看相关商品](#)